



Per Foot



IP Rated



Apogee
Microdrive



Industry
Exclusive
Warranty



Highest
Reliability



Easy
Installation



ETL
Listed



Custom
Kits

Features

OUTPUT

- Low: 2W / 200 Lumens per foot
- Standard: 3.5W / 375 lumens per foot
- High: 5W / 580 lumens per foot
- Lumen outputs based on 3000K / 80 CRI
- See Lumen factor chart for other CCT's.

DRIVER

- No Remote Driver. Onboard 120V Microdriver compatible with ELV dimming. Triac dimming available by request only, consult factory for dimmer compatibility.

OPTICS

- Patent pending co-extruded white PVC reflector for beam control and optimal light extraction.

OPTIONS

- 10kv Surge protection module (1 per AC feed)
- Remote Thermistor for overheating protection in outdoor applications where temperature could exceed 100F.

CONNECTORS

Indoor Connector: Patented, Direct BX connection for code compliant commercial installations. Available in straight, 90 degree, and cove tilt feed options. 5' feed cord is standard .15' feed cord optional.

Outdoor Connector: IP66 rated, SJ Cord connection with strain relief. Ships with Heyco liquid tight cord grip for junction box termination.

Portable Cord and Plug Option:

Wet Location SJ cord with 2 prong plug. 5' feed cord is standard .15' feed cord optional.

MOUNTING OPTIONS

- Adjustable Stainless Steel Hat Clip (2 per foot)
- Fixed Stainless Steel Hat Clip (2 per foot)
- Polycarbonate continuous rigid channel available in clear or white.
- Polycarbonate Flex Track
- 45 Degree Cove Tilt Track

HOUSING

- Extruded thermoplastic jacket with PVC end caps. Cuttable every 4" and terminated to customer specified run lengths.
- 100' Rolls are standard stocked length.
- Custom Roll sizes available, consult factory for lead time.

SOURCE

- 2.5 Step Macadam Color binning for consistent color over long runs.
- Proprietary VGS binning for output consistency with AC line fluctuation.
- Standard CCT's 2700K, 3000K, 3500K, 4000K, 5000K. 6500K available by special order, consult factory.
- Standard 80 CRI, 90 CRI optional for 2700k-4000k CCT.

CERTIFICATIONS

- ETL / cETL Listed for hardwire in accordance with UL1598
- UL 2108 Wet location listed for Cord and Plug portable option
- IP66 Rated Outdoor Hardwire
- US Patent 10,557,623
- Other patents pending

Technical Drawings

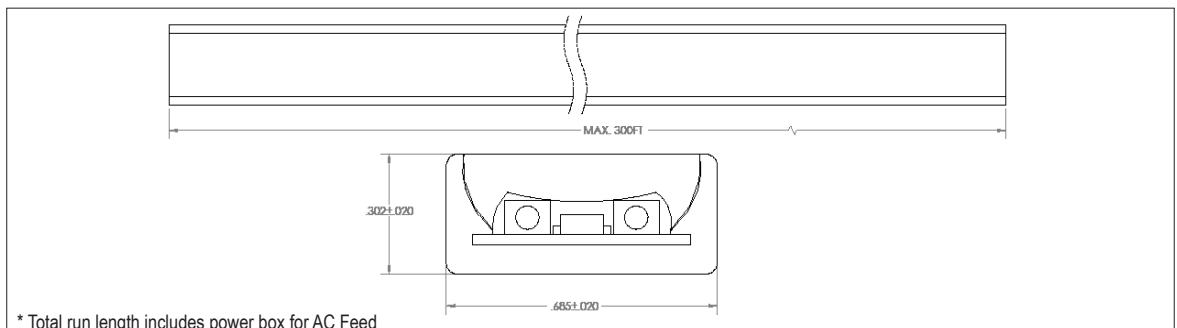

Lumen Factor

LUMEN FACTOR	
CCT	MULTIPLIER
2700K	0.96
3000K	1
3500K	1.03
4000K	1.05
4500K	1.05
5000K	1.05
6500K	1.05

Photometrics

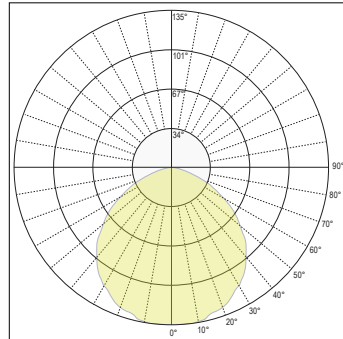

100' Fixture Run Competitive Comparison

Typical Low Voltage LED Fixture (Section length is limited to 20' maximum)

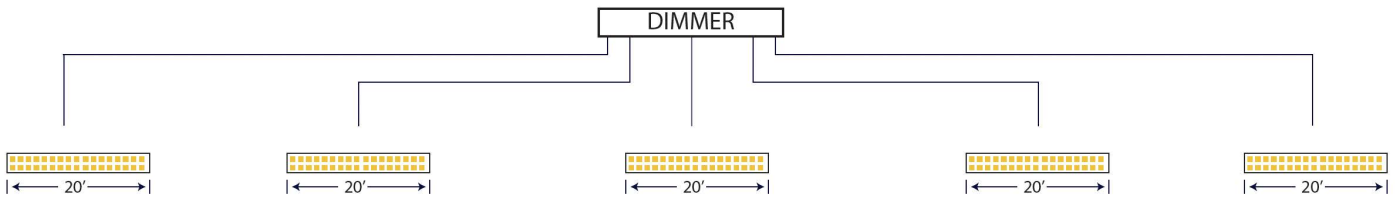

100' run of typical low voltage LED fixture requires FIVE 20' individually wired fixtures with 5 junction boxes



SaberFlex AC has a max run length of 100' from one voltage feed
 ** Max run includes all runs chained together with our linking adapter.



Power Feed Options

STANDARD POWER FEED*

For Cove, Under Cabinet, or Surface Mount installation with code compliant BX Terminator + Strain Relief.

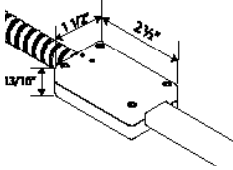

RIGHT ANGLE POWER FEED*

Can be used in any orientation to meet design requirements. Specify LED face down (D) or up (U). Standard is 1 FT from away from right angle feed.

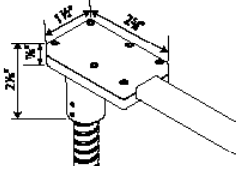

COVE CONNECTOR 45 DEGREE BX CONNECTOR*

Can be used in many orientations. All cove connector installations require approved submission drawings prior to shipment. Used in conjunction with the AC FlexTrack mounting track.

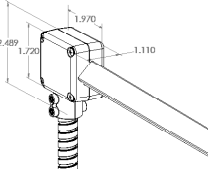

BX LINKING KIT**

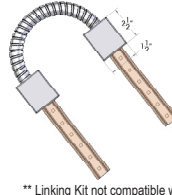

** Linking Kit not compatible with IP connectors or outdoor applications.

IP RATED CONNECTOR WITHOUT PLUG.

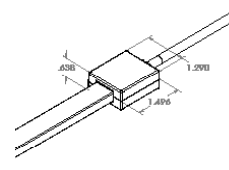

IP RATED CONNECTOR WITH PLUG.

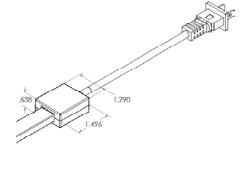

*BX Power feeds are for indoor applications only and are not compatible with any outdoor accessories.

Accessories

STANDARD MOUNTING TRACK

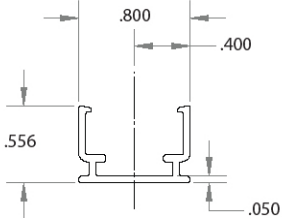

MULTI ANGLE MOUNTING CLIP

Adjustable spring steel clip for setting beam angle or cove installations. Used in conjunction with Flex or Standard Track. Recommended 2 per foot.

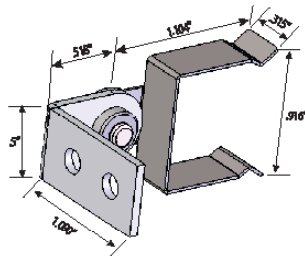

BOX LENS

Snap over rectangular lens with side light. Satinice acrylic, 87% transmissive.

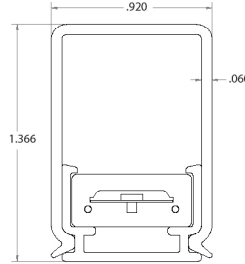

ROUND LENS

Snap over round lens with side light. Satinice acrylic, 87% transmissive.

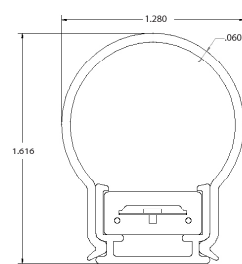

* Lenses are not compatible with the IP connector and are designed for indoor use only. Consult factory for custom outdoor lens configurations.

FLEX TRACK

Flex track mates with standard track, allows for wavy or curved installations. Available in vertical (PCTF) bending only.

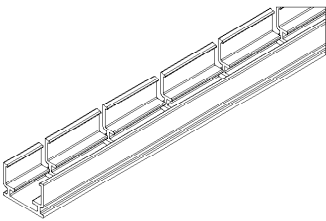

OUTDOOR ALUMINUM CHANNEL WITH MOUNTING TRACK

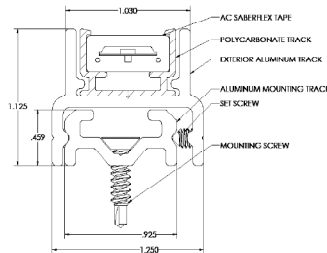

45 DEGREE COVE TRACK

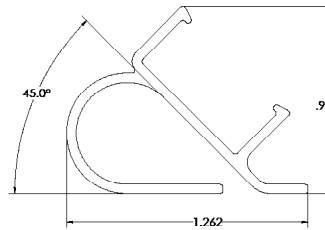

STAINLESS STEEL HAT CLIP

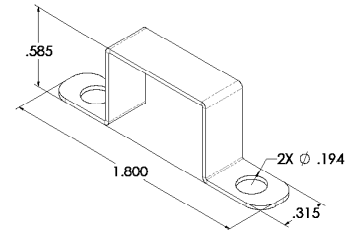

ORDERING INFORMATION FOR SABERFLEX AC®

SERIES	CRI	COLOR	OUTPUT	LENGTH	POWER FEED	CONTROL	MOUNTING	ACCESSORIES		
SFAC - SaberFlex AC	8 - 80 CRI minimum	27 - 2700K	L - Low output (200Lm/Ft)	RUN***	BX - Standard Straight BX	STD - ELV Dimming	SSC - Multiangle Stainless Clip	BL - Snap on box lens*****		
	9 - 90 CRI minimum*	30 - 3000K	S - Standard out- put (375Lm/Ft)				BXRAD - Right angle BX LED down	T - Triac Dimming (consult factory)****	SHC - Stainless Steel Hat Clip	RL - Snap on round lens*****
		35 - 3500K	H - High output (580Lm/Ft)				BXRAD - Right angle BX LED up		PCT - Clear PC Continuous Track	SP - Surge Protector
		40 - 4000K					BX45 - 45 Degree BX		PCTW - White PC Continuous track	15 - 15' feed cord
		50 - 5000K					IP - Standard IP		PCTF - PC Flex Track	Other - Consult Factory
		65 - 6500K**					IPCP - Straight IP with 5Ft Cord and Plug		PCT45 - 45 Degree Tilt Cove Track	LDCM - 0-10V Dimming Converter
					AT - Outdoor Aluminum Track	TH - Remote Termistor				
							LC - BX Linking connector kit			

Sample Number: SFAC-8-27-S-RUN-BX-STD-PCT-RL

NOTES

*90 CRI option available on 2700k - 4000k only

**Special orders only - consult factory

***Includes length of connector power feed box

****Triac Dimming is special order only at Apogee's discretion, consult factory

*****BL & RL require standard mounting track. Flex track, aluminum outdoor track and 45 degree track are not compatible

